

NOVARA 
MED



A Novara Med traz soluções inovadoras para os estabelecimentos de saúde.
Design sofisticado que possibilita praticidade nas operações diárias dos profissionais. Tecnologia e inovação se fazem presentes em seus produtos, proporcionando o conforto e o bem estar necessários.

RECEPÇÃO

Espaços que oferecem aconchego e conforto.





Balcão recepção reto

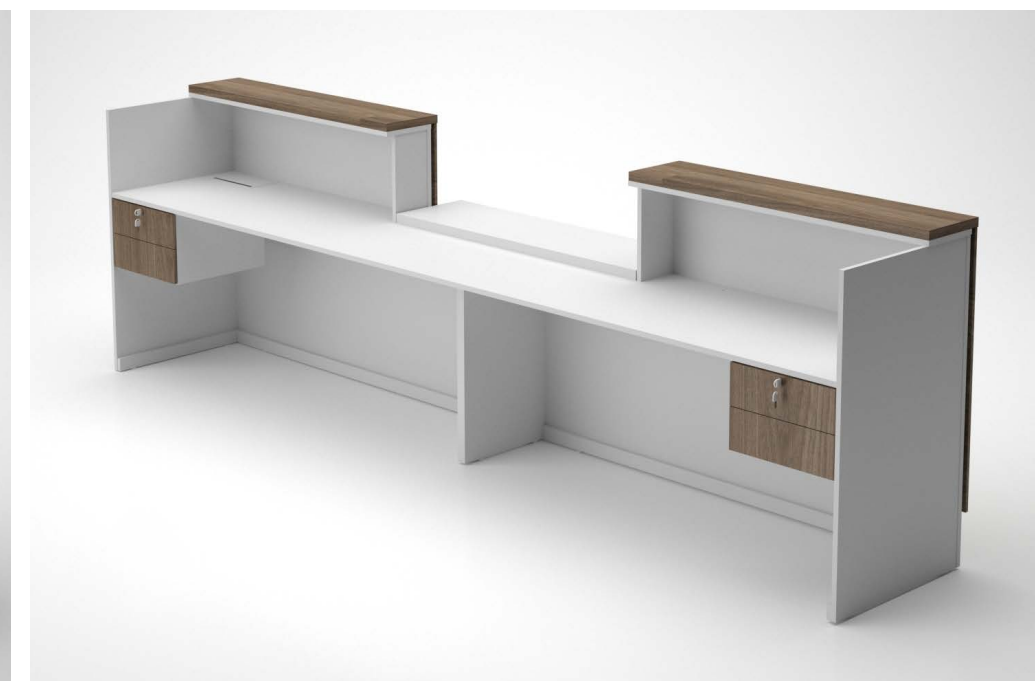
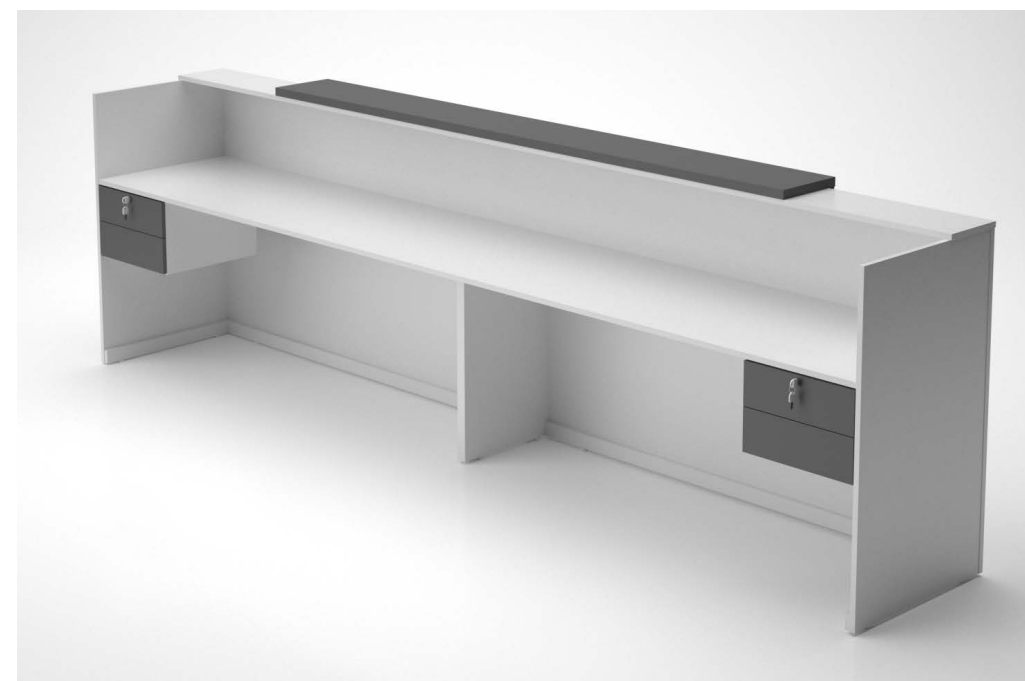
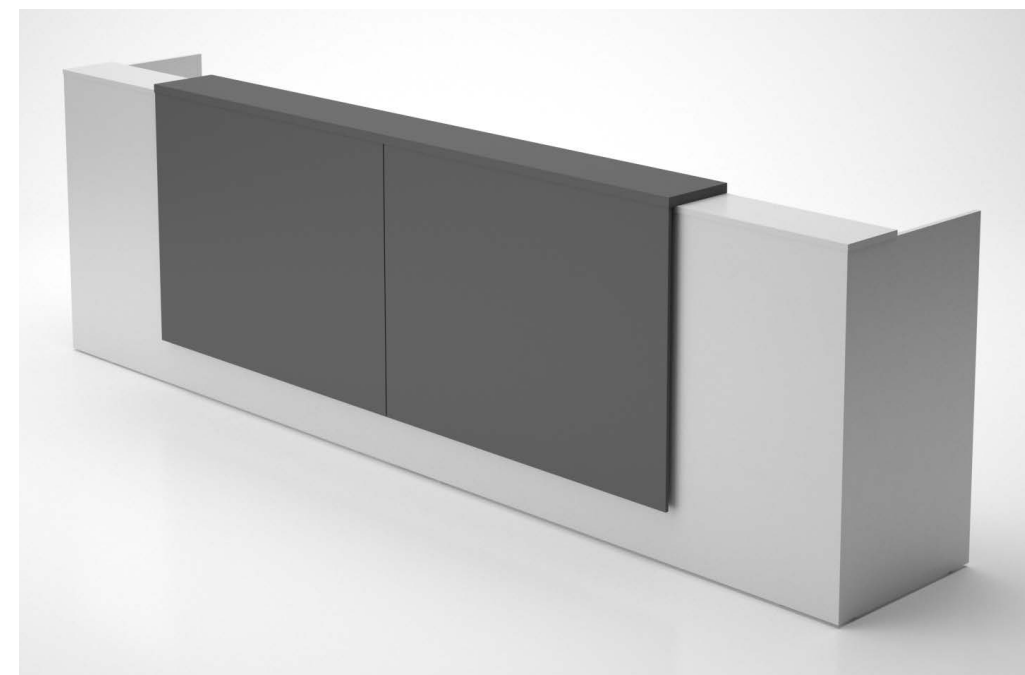

Balcão recepção em L

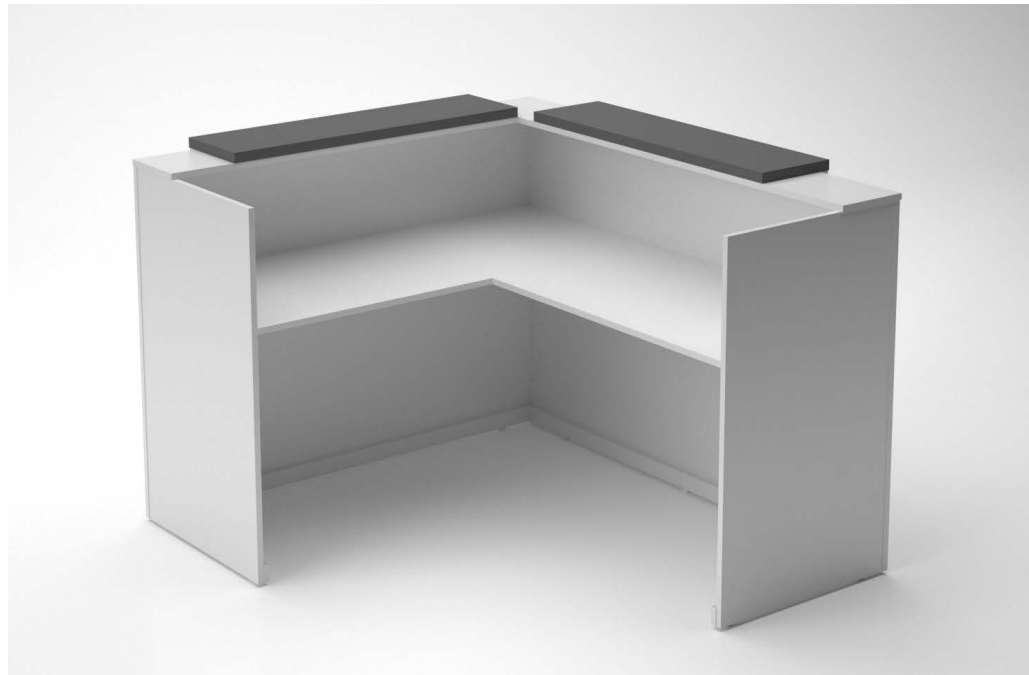
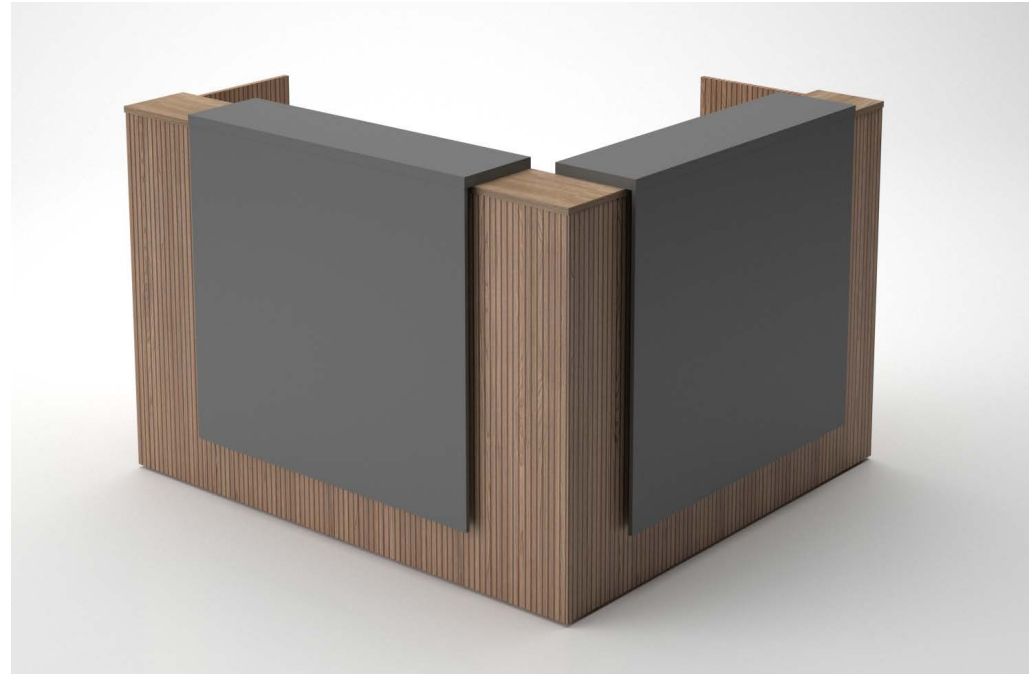

Balcão recepção em U



Acessórios balcão

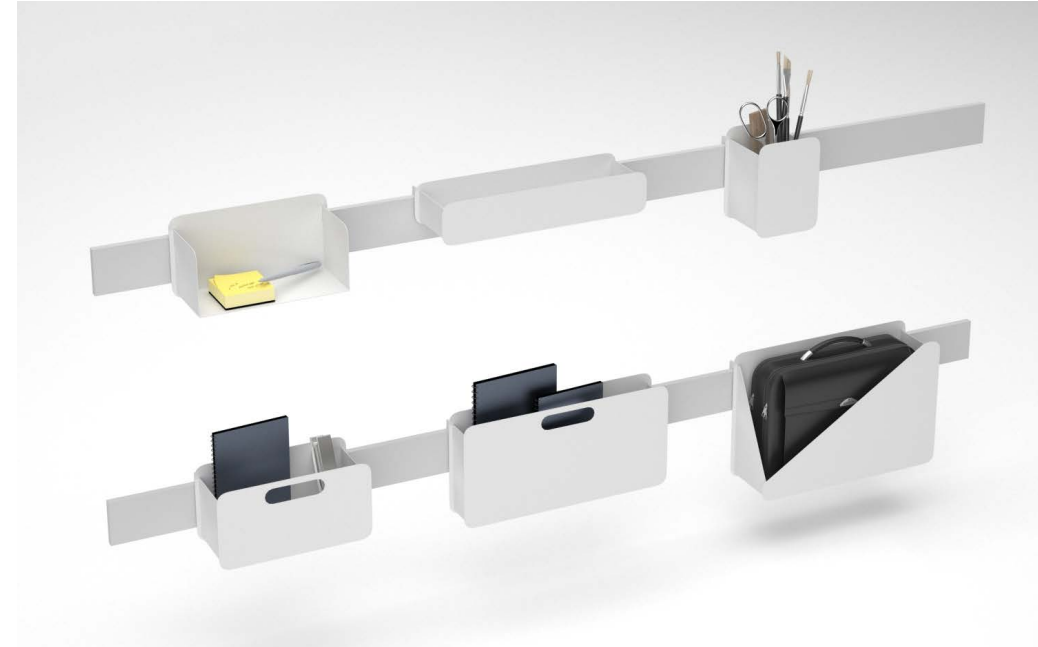

Carregador de celular



Estofados

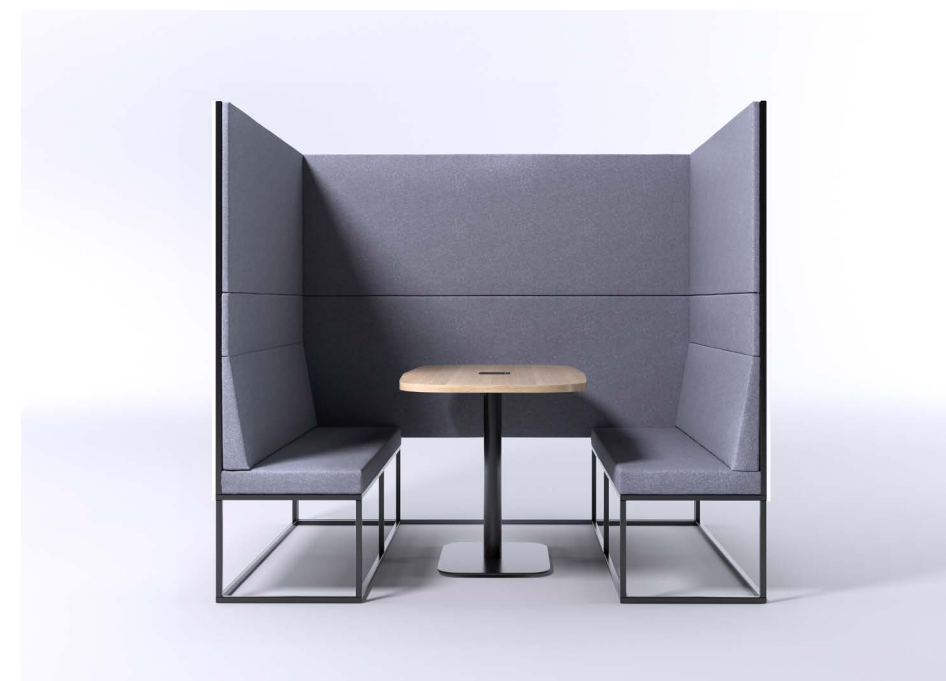

Armários



Ficheiros



Locker



Bancadas

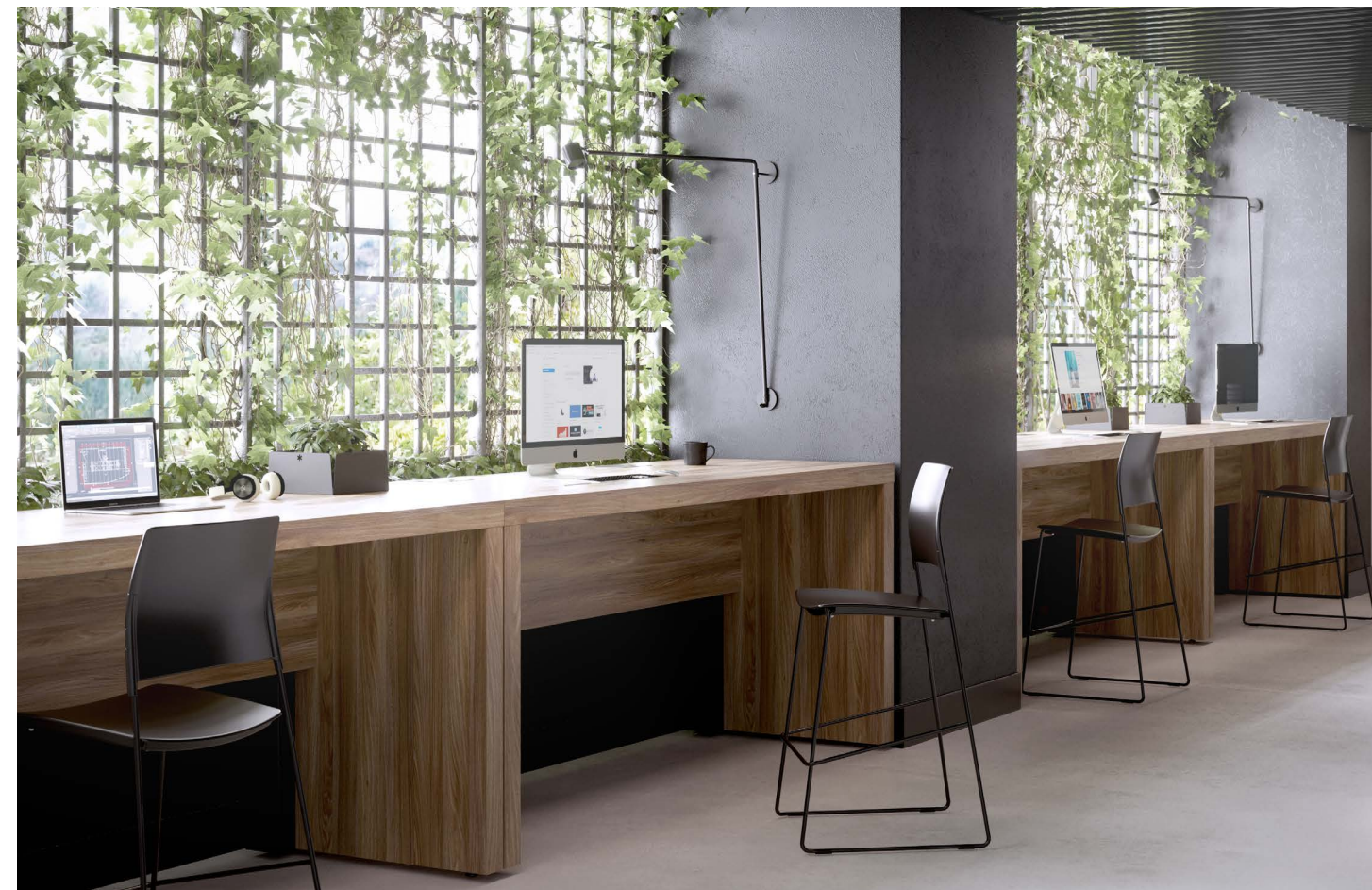

Flip chart



Mesas de centro e laterais



Armário café / Água



Carrinho café





CONSULTÓRIO

Praticidade e sofisticação proporcionam uma personalidade única ao ambiente.







Suporte monitor

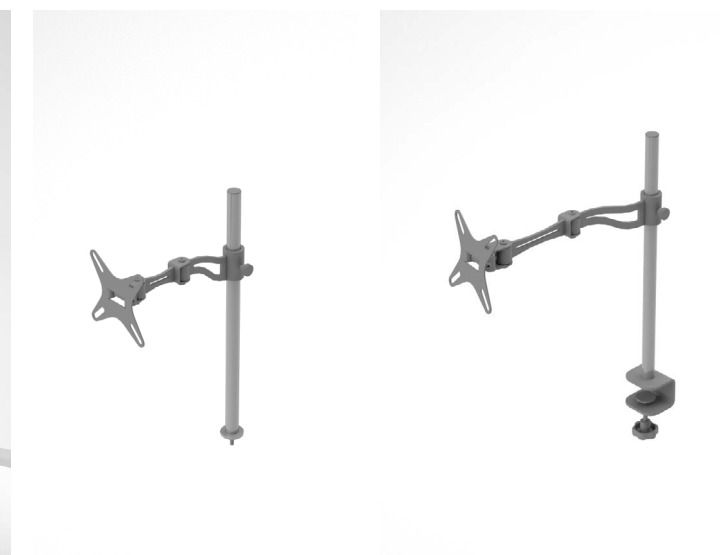





Macas - MDP BP

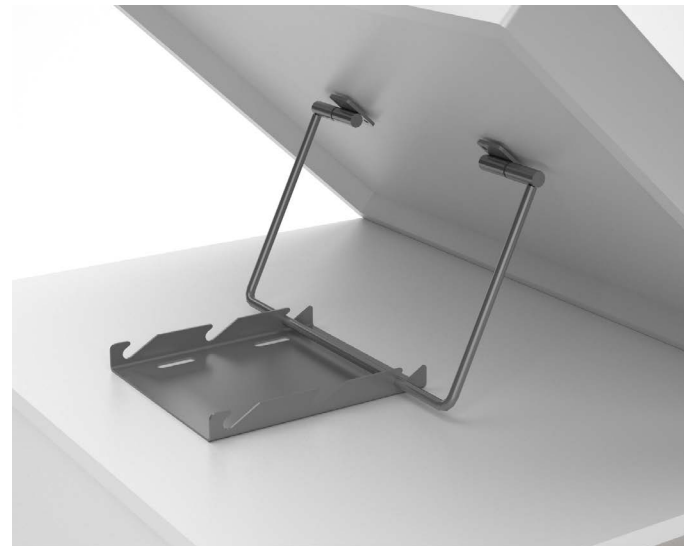

Macas - Tubo metálico





CLÍNICA/HOSPITAL

Produtos com soluções confiáveis e de qualidade.



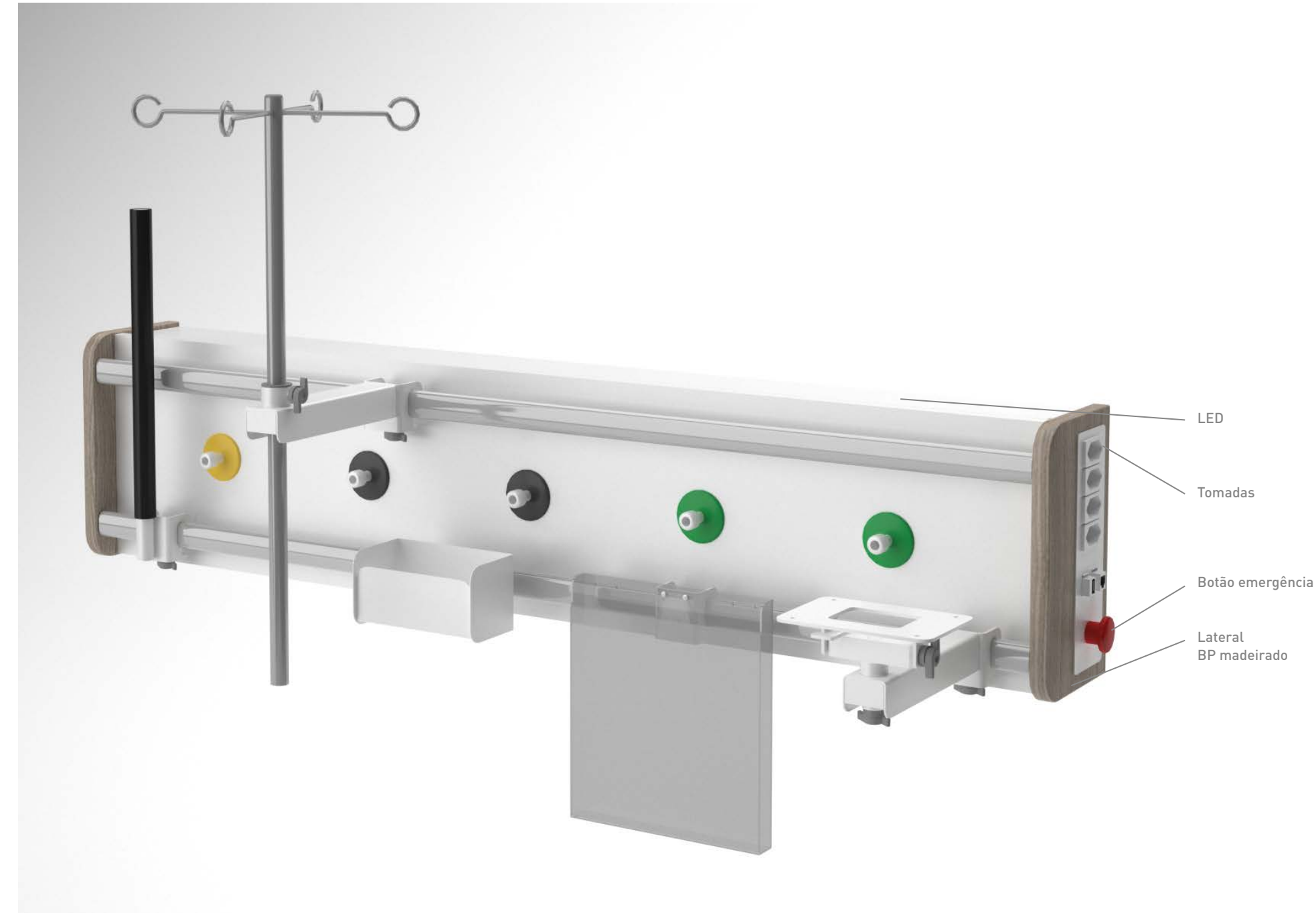

Suporte para soro de piso



Suporte para soro de encaixe



Suporte bomba Infusão



Suporte tablet

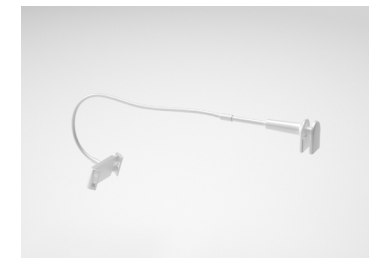

Lâmpada foco



Porta objetos



Suporte monitor multiparametros

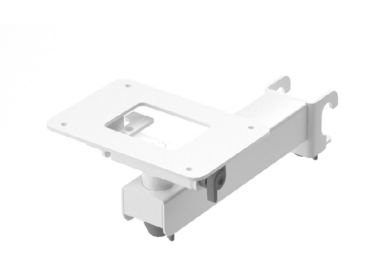

Porta folhas - Porta prontuário



Suportes universal para maca

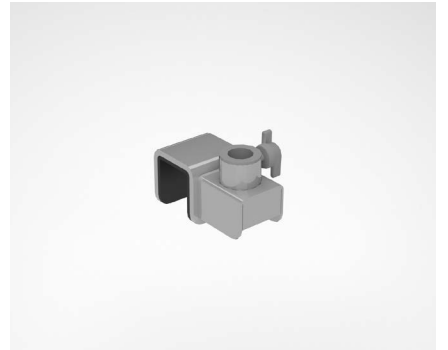
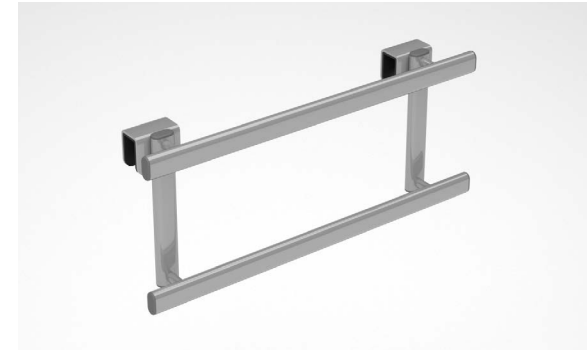
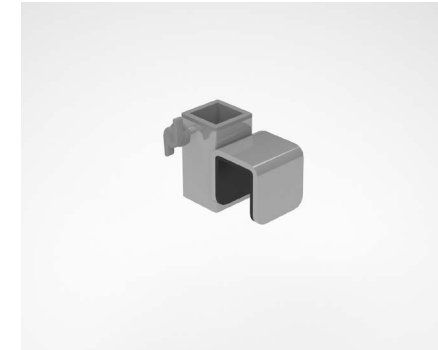

Módulos para descarte



Mesas de apoio



Biombo divisor articulado

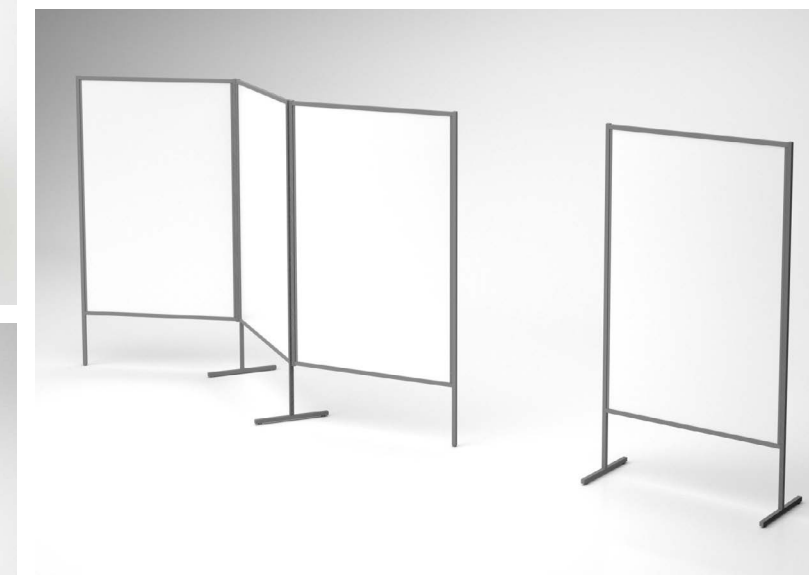

Mesas para refeição



ACABAMENTOS X USOS

MDP MADEIRADO

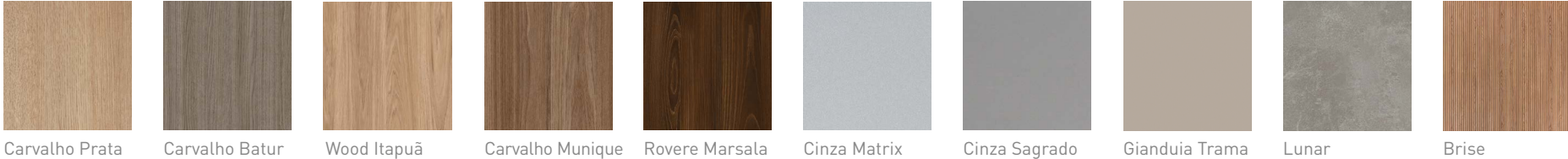

MDP LISO

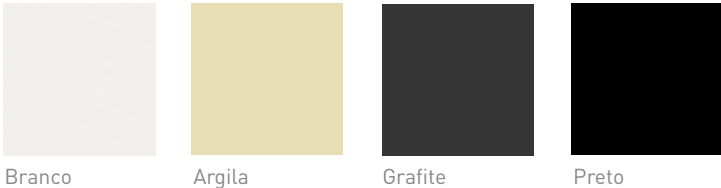

PINTURA GOFRATO

PORTAS LOCKERS

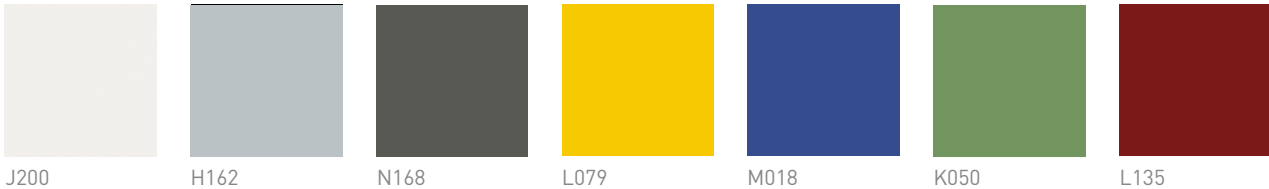

METÁLICO



TECIDOS CREPE

MEET



LOUSA

FLIP CHART E ANTEPAROS BALCÃO RECEPÇÃO

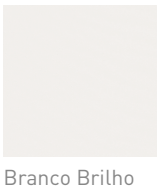

MADEIRA

PÉS MESA TREVI



A Novara Med atende especificamente ambientes de assistência em saúde. Com mais de 50 anos de experiência no setor moveleiro, alia tradição e inovação.

Desenvolvemos e entregamos um ambiente prático e acabamento diferenciado. Nosso design inovador oferece o conforto que o momento exige.



A marca da gestão florestal responsável

Compromisso pela conservação do meio ambiente.

PESSOAS E AMBIENTES





Rua Evaristo de Antoni, 3013/3022, Caxias do Sul - RS
+55 54 3027.1818 - www.novara.ind.br